Model No:LZ-5054NDE2

Warm white TOP LED (5050)

Lead(Pb) Free Product-ROHS Compliant

■ Applications

1. Interior automotive lighting(dashboard backlight etc...)
2. Optical indicators
3. Communication Products
4. Backlighting
5. Flash
6. Illuminations

■ Package Dimensions

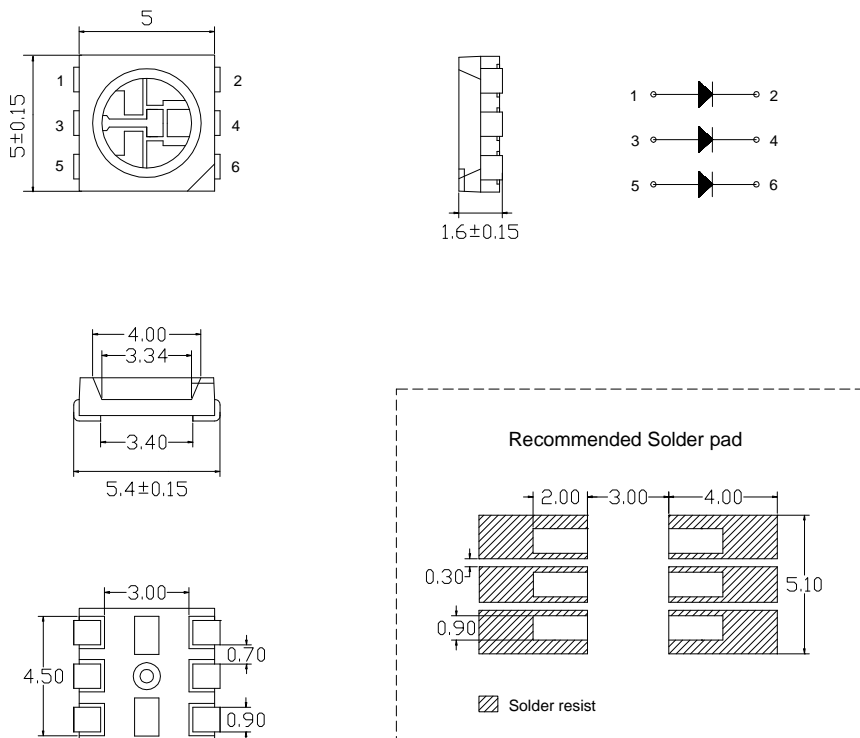

Notes:

All dimensions in mm tolerance is ± 0.1 mm unless otherwise noted.

■ Absolute Maximum Ratings (Ta = 25°C)

Items	Symbol	Absolute maximum Rating	Unit
Power Dissipation	P _D	3*100	mW
Forward Current(DC)	I _F	3*25	mA
Peak Forward Current**	I _{FP}	3*100	mA
Operation Temperature	T _{opr}	-40~ +85	°C
Storage Temperature	T _{stg}	-40 ~ +100	°C

**Pulse width ≤ 0.1msec duty ≤ 1/10

■ Typical Electrical & Optical Characteristics (Ta = 25°C)

Items	Symbol	Condition	Min.	Typ.	Max.	Unit
Forward Voltage	V _F	I _F = 3*20mA	2.8	3.2		V
Reverse Current	I _R	V _R = 5V	---	---	10	μ A
Chromatic Coordinates	CCT	I _F = 3*20mA	2800	2950	3200	K
Luminous Intensity	I _V	I _F = 3*20mA	4600	5000	---	mcd
Luminous flux	Flux	I _F = 60mA	‘---	9.8	‘---	lm
50% Power Angle	2 θ ½	I _F = 3*20mA	---	120	---	Deg

■ Ranks Combination (IF = 60mA)

Rank	V2	W1
Luminous Intensity(mcd)	4188-5235	5235-6543

■ Notes

1. Tolerance of measurement of luminous intensity : ±15%
2. Tolerance of measurement of chromatic coordinates : ±0.02
3. Tolerance of measurement of forward voltage : ±0.1V

■ Chromatic Coordinates Ranks

	N11		N12		N13		N14			
X	0.4400	0.4496	0.4496	0.4592	0.4592	0.4694	0.4694	0.4797		
Y	0.4530	0.4568	0.4568	0.4606	0.4606	0.4635	0.4635	0.4663		
X	0.4473	0.4568	0.4568	0.4666	0.4666	0.4768	0.4768	0.4870		
Y	0.4428	0.4467	0.4467	0.4504	0.4504	0.4532	0.4532	0.4560		
	N21		N22		N23		N24			
X	0.4378	0.4473	0.4473	0.4568	0.4568	0.4666	0.4666	0.4768		
Y	0.4390	0.4428	0.4428	0.4467	0.4467	0.4504	0.4504	0.4532		
X	0.4449	0.4546	0.4546	0.4641	0.4641	0.4740	0.4740	0.4840		
Y	0.4291	0.4327	0.4327	0.4365	0.4365	0.4404	0.4404	0.4432		
	N31		N32		N33		N34			
X	0.4270	0.4359	0.4359	0.4449	0.4449	0.4546	0.4546	0.4641		
Y	0.4197	0.4244	0.4244	0.4291	0.4291	0.4327	0.4327	0.4365		
X	0.4342	0.4431	0.4431	0.4522	0.4522	0.4616	0.4616	0.4712		
Y	0.4096	0.4143	0.4143	0.4191	0.4191	0.4228	0.4228	0.4267		
	N41		N42		N43		N44		N45	
X	0.4168	0.4253	0.4253	0.4342	0.4342	0.4431	0.4431	0.4522	0.4522	0.4616
Y	0.3995	0.4049	0.4049	0.4096	0.4096	0.4143	0.4143	0.4191	0.4191	0.4228
X	0.4243	0.4328	0.4328	0.4416	0.4416	0.4505	0.4505	0.4594	0.4594	0.4689
Y	0.3891	0.3947	0.3947	0.3993	0.3993	0.4040	0.4040	0.4087	0.4087	0.4127
	N52		N53		N54		N51			
X	0.4243	0.4328	0.4328	0.4416	0.4416	0.4505	0.4159	0.4243		
Y	0.3891	0.3947	0.3947	0.3993	0.3993	0.4040	0.3836	0.3891		
X	0.4312	0.4396	0.4396	0.4485	0.4485	0.4574	0.4229	0.4312		
Y	0.3794	0.3849	0.3849	0.3896	0.3896	0.3943	0.3738	0.3794		

■ Typical Electrical/ Optical Characteristics Curves (Ta=25°C Unless Otherwise Noted)

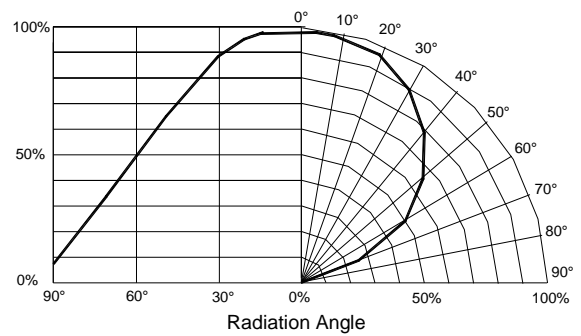
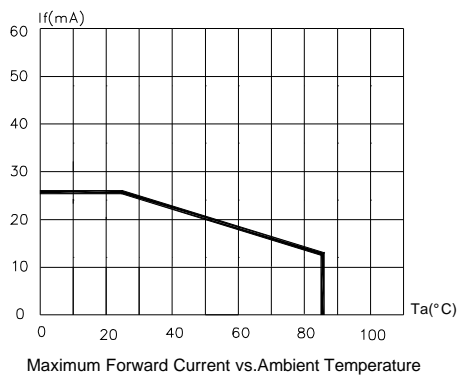
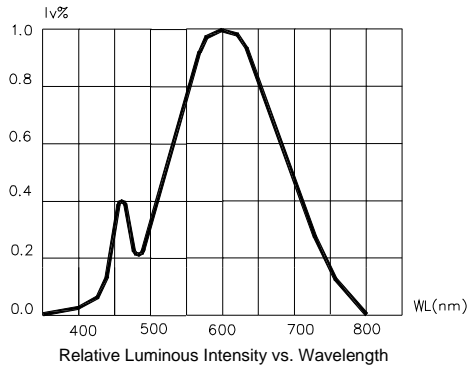
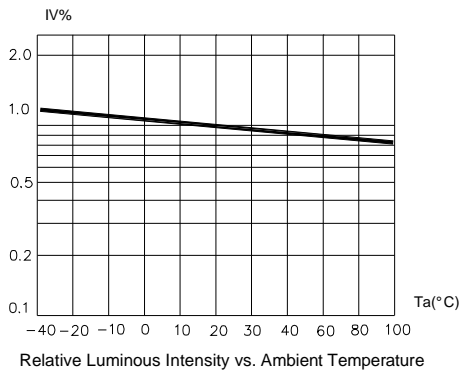
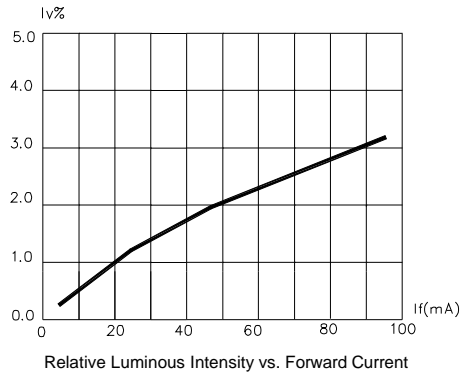
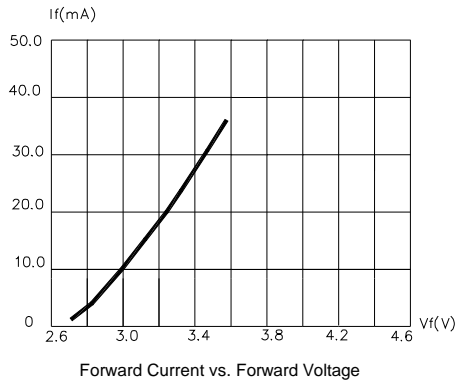

■ Soldering heat reliability:

Lead Solder

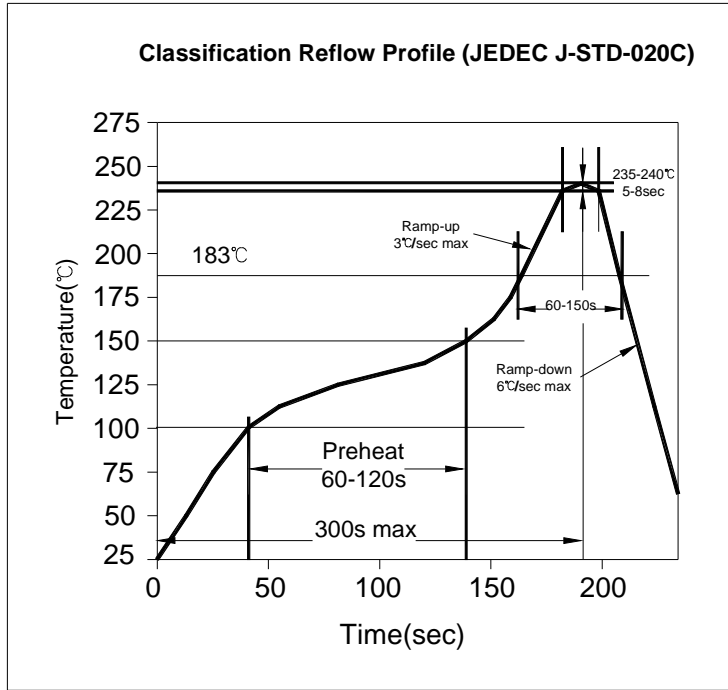

Lead Free Solder

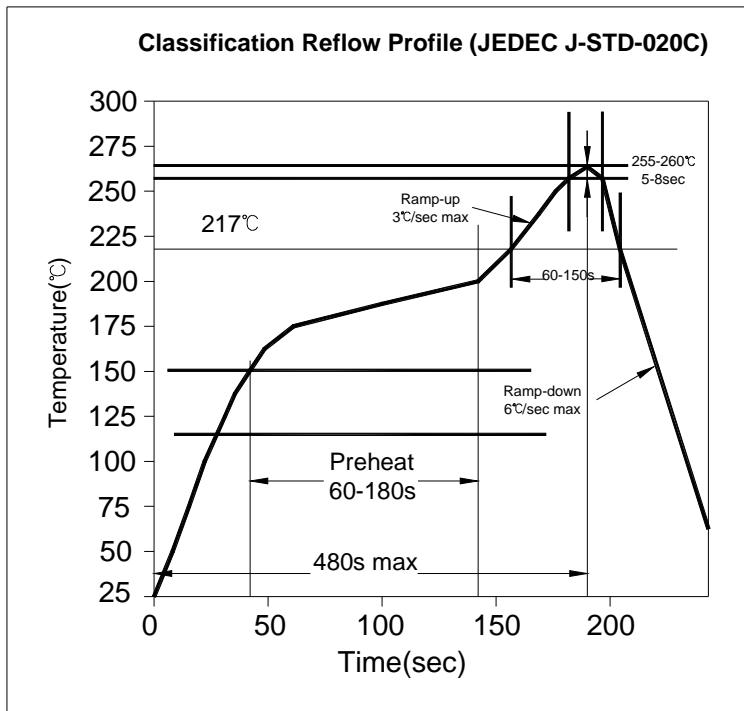

■ Packing Specifications:

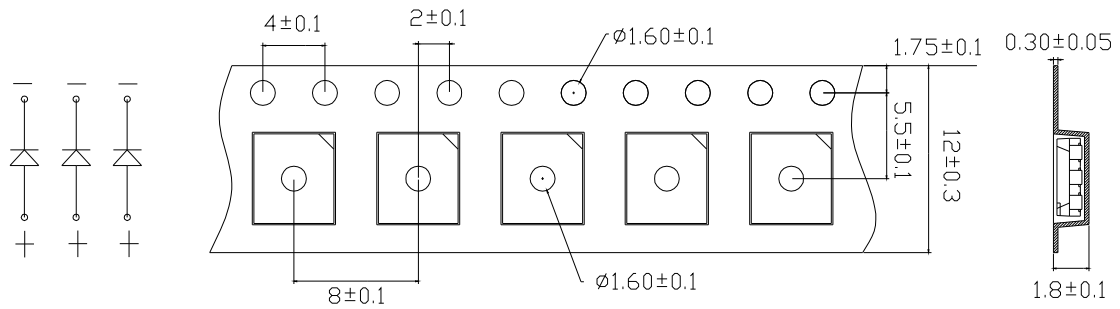

■ Reel Specifications

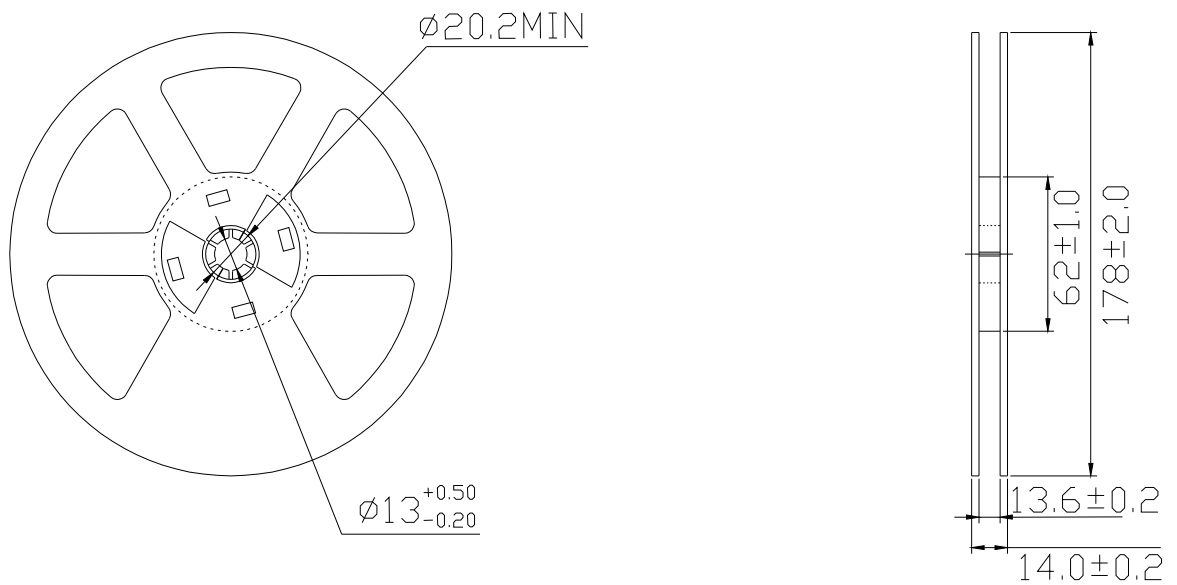

Dimensions are specified as follows: mm

Notes:

- 1) The packing only appropriate for LZGD
- 2) Normal packing quantity: 1,000pcs/reel

■ Handling Precautions

Compare to epoxy encapsulant that is hard and brittle, silicone is softer and flexible. Although its characteristic significantly reduces thermal stress, it is more susceptible to damage by external mechanical force.

As a result, special handling precautions need to be observed during assembly using silicone encapsulated LED products. Failure to comply might lead to damage and premature failure of the LED.

1. Handle the component along the side surfaces by using forceps or appropriate tools.

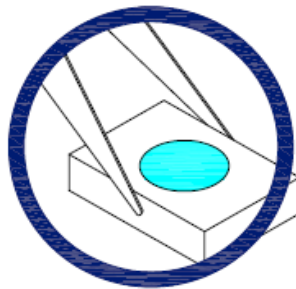

2. Do not directly touch or handle the silicone lens surface. It may damage the internal circuitry.

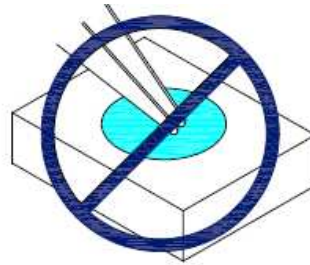

3. Do not stack together assembled PCBs containing exposed LEDs. Outside impact may scratch the silicone lens or damage the internal circuitry.

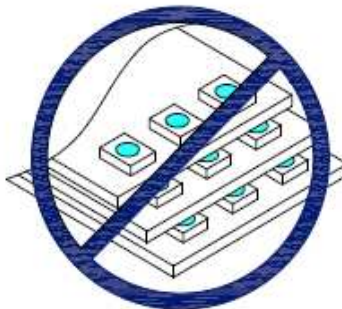

4. The outer diameter of the TOP LED pickup nozzle should not exceed the size of the LED to prevent air leaks. The inner diameter of the nozzle should be as large as possible.

-
5. A pliable material is suggested for the nozzle tip to avoid scratching or damaging the LED surface during pickup.
 6. The dimensions of the component must be accurately programmed in the pick-and-place machine to insure precise pickup and avoid damage during production.

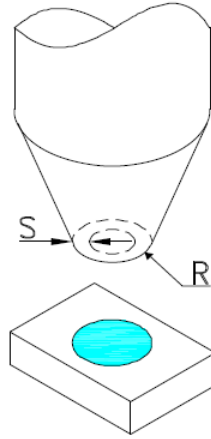

Revision History					
Rev.No.	Change Description	Date	Prepared By	Checked By	Approved By
01	New-made specification	2009/3/16	LF	LF	LF